

Swim Spa Operator's Guide

Includes
Installation, Operation, Maintenance and
Safety Information

NOTE

SAVE THESE IMPORTANT SAFETY INSTRUCTIONS

This manual contains important safety, operating, and installation instructions - read before installing or operating swim spa.

OWNER'S INFORMATION

DEALER IMPRINT AREA

Installer

Company: _____

Address: _____

Phone: _____

Warranty Submitted: _____

**PLEASE ASK YOUR DEALER ABOUT REGISTERING
YOUR WARRANTY**

Model: _____

Serial Number: _____

Equipment Pack: _____

Color: _____

Date of Delivery: _____

We appreciate your business and our sincere desire is that you receive years of pleasure and therapy from your swim spa. Please call your local swim spa dealer if you have any questions or problems.

TABLE OF CONTENTS

SAFETY INSTRUCTIONS	3-10	SWIM SPA SHEMATICS	34-41
Warning Tags		12', 13', 13' Party , 14' , 16', 17' and 19'	
BASIC INFORMATION	11	GENERAL SWIM SPA	
SET UP & DELIVERY GUIDELINES	12-15	MAINTENANCE	42-43
Surface and Pad Requirements		Pillows	
Balcony and Deck		Jets	
Access		Surface	
Outdoor Installation		Spa Cover	
Indoor Installation		Draining	
Electrial Requirements		WINTERIZING AND	
YE REQUIREMENTS	16-19	SPRINGTIME START-UP	44
Wiring Diagram		TROUBLESHOOTING	45-46
Connections		NOTES AND DISCLAIMERS	47-48
Configurations			
GENERAL PRE-OPERATION			
INSTRUCTIONS	20		
Priming Pump			
SWIM SPA TERMINOLOGY	21-23		
Jets			
Water Diverter			
Water Fountain Jets			
Waterfall			
Air Control			
Access Panel			
Swim Spa Lights			
Swim Spa Heater			
Gate Valves			
Pumps			
FILTER LOCATIONS	24-25		
Maintenance			
Cleaning			
TOPSIDE CONTROLS	26		
K450			
K1000			
WATER CARE	27-29		
Cleaning			
Filling			
Water Tests			
Chemical Use			
EXERCISE EQUIPMENT HOOK-UP	30-31		
Equipment Hook-Up			
EXERCISE SUGGESTIONS	32-33		

This Operator's Guide utilizes the following symbols to emphasize particular information.



The Safety Alert Symbol indicates a potential hazard



WARNING



NOTE



CAUTION!

WARNING/CAUTION TAGS DIAGRAM

NO CLIMBING OR WALKING ON TOP RAIL

⚠ DANGER

**SHALLOW WATER
NO DIVING - NO JUMPING**

**DIVING OR JUMPING MAY
CAUSE DEATH, PARALYSIS OR
PERMANENT INJURY**

**FAILURE TO FOLLOW THESE RULES
MAY CAUSE DEATH, PARALYSIS OR PERMANENT INJURY**

HOW TO PREVENT DIVING/JUMPING ACCIDENTS

- This is a non-diving pool/swim spa system.
- Do not dive or jump into this pool/swim spa under any circumstances.
- Do not utilize sliding equipment with this pool/swim spa system.
- Do not utilize diving equipment with this pool/swim spa system.

HOW TO PREVENT CHILD DROWNING ACCIDENTS

- Children must be constantly and closely supervised when using the pool/swim spa system.
- Children must not be allowed in the pool/swim spa system area without an adult being present.
- The pool/swim spa system cover must be closed and locked when the pool/swim spa system is not being used.
- Portable ladders must be removed when not in use.
- Limited access ladders must be removed or latched in the raised position when not in use.

HOW TO PREVENT OTHER ACCIDENTS

- Do not swim alone.
- Do not use the pool/swim spa system if you taken drugs or consumed alcohol.
- Non-swimmers must stay in the shallow end of the pool/swim spa system.

For additional information please read the safety and usage information supplied in the Installer/Owner envelope.

EMERGENCY PHONE NUMBER

⚠ CAUTION

Please avoid using any spa chemicals that contain Hydrogen Peroxide. Hydrogen Peroxide based spa chemicals have been found to react adversely with the materials used to produce these components. We recommend the use of Chlorine and Bromine based products only. Any structural and/or cosmetic jet failure linked to the use of Hydrogen Peroxide based products will not be covered under your warranty.

Please consult your Dealer for approved chemical options.

Merci de ne pas utiliser de produits chimiques pour spas contenant du Peroxide d'Hydrogene. Les produits pour spas à base de Peroxide d'Hydrogene produisent une réaction chimique qui va detriorer les jets. Nous recommandons l'utilisation de produits à base de Chlore ou de Brome seulement. Aucun jet detrioré avec du Peroxide d'Hydrogene ne pourra être couvert par la garantie.

Merci de consulter votre revendeur pour obtenir des conseils sur les produits chimiques compatibles.

001222-072400

⚠ ATTENTION

**INSTALL FILTERS
BEFORE FILLING SPA!**

1. Remove filters from plastic bag.
2. Carefully thread filters into fittings
3. DO NOT OVERTIGHTEN. A snug fit is all that is required.

AVANT DE METTRE DE L'EAU :

1. Enlever le plastique sur les cartouches de filtration.
2. Vesser les cartouches dans l'emplacement.
3. NE PAS SERRER TROP FORT, il suffit d'ajuster les cartouches.

001221-072400

NO DIVING

SHALLOW WATER • NO JUMPING

**DIVING OR JUMPING MAY CAUSE DEATH, PARALYSIS
OR PERMANENT INJURY**

NO CLIMBING OR WALKING ON TOP RAIL

SAFETY DO'S AND DONT'S / DANGER SIGN

⚠ ATTENTION

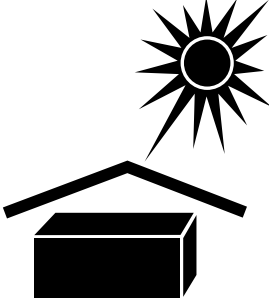

KEEP FROM HEAT

**FAILURE TO DO SO WILL
RESULT IN VOID OF WARRANTY.**

DO

- DO read all operating instructions.
- DO read, understand and follow all safety, danger and warning instructions before use.
- DO test water temperature with your hand before entering.
- DO keep the cover down when the swim spa remains unused.

DO NOT

- DO NOT block or sit on the filter recess area.
- DO NOT allow horseplay or unsupervised use of your swim spa.
- DO NOT allow anyone to tamper or play with any of the safety or suction fittings of your swim spa.

DANGER SIGN

Every swim spa has a warning sign that outlines safety precautions. Read and familiarize yourself with all warnings listed on this sign. Make the sign visible and accessible to all swim spa users.

Replacement signs may be obtained from our Media Department: mediaservices@dynamstypas.com

SAFETY INSTRUCTIONS

SAVE THESE INSTRUCTIONS

Included with your new swim spa is a safety sign. The sign is for you and your guest's protection and is suitable for outdoor use in wet locations. The sign should be placed in a location visible to all users of the swim spa.

Please take time to point out the physical location of the safety sign and the importance of the safety precautions displayed on the safety sign to all of your guests. Remember, your safety and the safety of anyone who enjoys the use of your swim spa is our utmost concern.

The sign should be mounted with screws or another type of permanent fastener. Additional or replacement signs can be obtained from your dealer or direct from our factory.

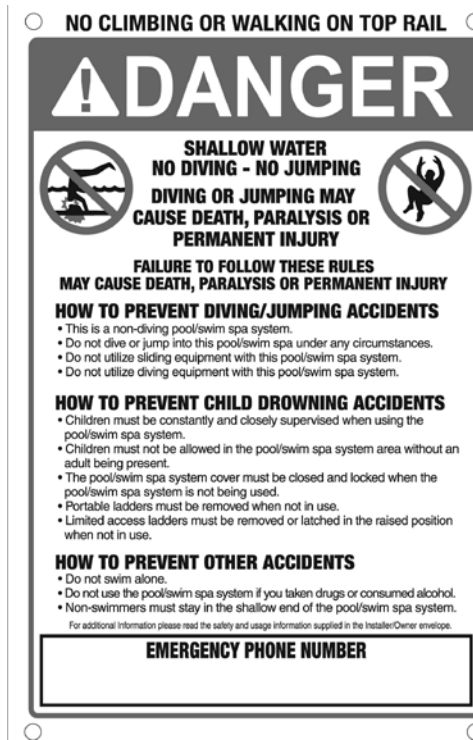

IMPORTANT SAFETY INSTRUCTIONS

WARNING!

When installing and using this electrical equipment, basic safety precautions should be followed, including the following:

READ AND FOLLOW ALL INSTRUCTIONS

- 1) **WARNING** - To reduce the risk of injury, do not permit children to use this product unless they are closely supervised at all times.
- 2) **DANGER - RISK OF CHILD DROWNING.** Extreme caution must be exercised to prevent unauthorized access by children. To avoid accidents, ensure that children cannot use the swim spa unless they are supervised at all times.

NOTE: A grounding lug connector is provided on this unit to connect a wire of a minimum No. 6 AWG (6.4mm²) minimum 75°C copper conductor between this unit and any metal equipment, metal enclosures of electrical equipment, metal water pipe, or conduct within 5 feet (1.52 m) of the unit.

- 3) **DANGER - RISK OF ELECTRIC SHOCK.** Install swim spa at least five (5) feet (1.52 m) from all metal surfaces. A swim spa may be installed within five (5) feet (1.52 m) of metal surfaces if, in accordance with the National Electrical Code / IEC, each metal surface is permanently connected by a minimum No. 6 AWG (6.4mm²) minimum 75°C copper conductor attached to the wire connector on the terminal box. A grounding lug is provided for this purpose.
- 4) **DANGER - RISK OF INJURY.** The suction fittings in this swim spa are sized to match the specific water flow created by the pump. Should the need arise to replace the suction fittings or the pump, be sure that the flow rates are compatible.

NOTE: Never operate the swim spa if the suction fittings are broken or missing. Never replace a suction fitting with one rated less than the flow rate marked on the original suction fitting

- 5) **DANGER** - To reduce the risk of injury to persons, do not remove the suction grate. Suction through drains and skimmers is powerful when the jets in the swim spa are in use. Damaged covers can be hazardous to small children and adults with long hair. Should any part of the body be drawn into these fittings, turn off the swim spa immediately. As a precaution, long hair should not be allowed to float in the swim spa.
- 6) **WARNING.** Install the swim spa so that water can be easily drained out of the compartment containing electrical components so as not to damage equipment. Also, when installing swim spa, allow at least 2 feet of clearance around the perimeter of the swim spa to provide enough room to access for servicing. Contact your local dealer for their specific requirements.

IMPORTANT SAFETY INSTRUCTIONS

READ AND FOLLOW ALL INSTRUCTIONS

7) **WARNING - TO REDUCE THE RISK OF INJURY:**

- REMINDER - Never allow anyone to dive into a swim spa. Always enter feet first.
- Always enter and exit a swim spa slowly.
- Do not use the swim spa alone.
- Before entering the swim spa, always measure the water temperature with an accurate thermometer. Tolerance of water temperature regulating devices can vary as much as plus/minus 5° F (3° C). Persons suffering from obesity or with a medical history of heart disease, diabetes, high or low blood pressure or circulatory system problems should consult a physician before using a swim spa.
- Since excessive water temperatures have a high potential for causing fetal damage during early months of pregnancy, pregnant or possibly pregnant women should limit swim spa water temperatures to 100° F (38° C).
Excessive water temperature can be dangerous. The water in the swim spa should never exceed 104° F (40° C). Water temperatures between 100° F (38° C) and 104° F (40° C) are considered safe for a healthy adult. Lower water temperatures are recommended for extended use (exceeding 10 minutes) and for young children. Long exposures at higher temperatures can result in hyperthermia. The use of alcohol, drugs or medication before or during swim spa use may lead to unconsciousness with the possibility of drowning.
- Persons using medication should consult a physician before using a swim spa since some medication may induce drowsiness while other medication may affect heart rate, blood pressure and circulation. Children's body temperature can increase more rapidly than adults in the same water with elevated temperatures (above 99° F). Children should spend less time in water above body temperature than adults.
-

IMPORTANT SAFETY INSTRUCTIONS

READ AND FOLLOW ALL INSTRUCTIONS

WARNING - TO REDUCE THE RISK OF INJURY (CONT):

 **WARNING!**

HYPERTHERMIA

Hyperthermia occurs when the internal temperature of the body reaches a level several degrees above the normal body temperature of 98.6° F.

THE SYMPTOMS OF HYPERTHERMIA INCLUDE:

- Dizziness
- Fainting
- Drowsiness
- Lethargy
- Increase in internal body temperature

THE EFFECTS OF HYPERTHERMIA INCLUDE:

- Unawareness of impending hazard
- Failure to perceive heat
- Failure to recognize the need to exit swim spa
- Physical inability to exit swim spa
- Fetal damage in pregnant women
- Unconsciousness resulting in potential of drowning

- 8) **WARNING** - The use of alcohol, drugs or medication can greatly increase the risk of hyperthermia in hot tubs and swim spas.
- The use of alcohol, drugs, or medication before or during swim spa use may lead to unconsciousness with the possibility of drowning.
 - Persons using medication should consult a physician before using a swim spa since some medication may induce drowsiness while other medication may affect heart rate, blood pressure, and circulation.
- 9) **REMINDER** - A safe temperature for swimming or aquatic exercise is around 80° F.
- NOTE** - People with infections or sores should not use the swim spa. Warm and hot water temperatures may allow the growth of infectious bacteria if not properly disinfected.
- 10) **DANGER - RISK OF ELECTRIC SHOCK.** Do not permit any electric appliance, such as a light, telephone, radio or television within five (5) feet of the swim spa. Never operate any electrical appliances from inside the swim spa or while wet.
- 11) **WARNING - RISK OF SUFFOCATION.** If this swim spa is equipped with a heater, it is intended for outdoor use only, unless proper ventilation can be provided for an indoor installation.

IMPORTANT SAFETY INSTRUCTIONS

READ AND FOLLOW ALL INSTRUCTIONS

WARNING - TO REDUCE THE RISK OF INJURY (CONT):

- 12) **CAUTION - RISK OF ELECTRIC SHOCK.** Do not leave the Audio compartment open.
- 13) **CAUTION - RISK OF ELECTRIC SHOCK.** Replace components only with identical components.

- 14) **WARNING - PREVENT ELECTROCUTION.** Do not connect any auxiliary components (for example, additional speaker, headphones, additional audio/video components etc.) to the system. These units are not provided with an outdoor antenna.
 - Do not service this product yourself as opening or removing covers may expose you to dangerous voltage or other hazards. Refer all servicing to your qualified swim spa tech.
 - If the power supply/supply cord(s) are damaged, if water is entering the speaker, Audio compartment, or any other component in the electrical equipment compartment area, the protective shield is showing signs of deterioration, or there are signs of other potentially hazardous damage to the unit, turn off the circuit breaker from the wall and contact or refer to your service technician.
 - The unit should be subject to periodic routine maintenance once every quarter to make sure that the unit is operating properly.
- 15) **DANGER - RISK OF ELECTRIC SHOCK.** Do not permit any electric appliance, such as a light, telephone, radio or television within five (5) feet of the swim spa.
- 16) A green colored terminal or a terminal marked G, GR. Ground, Grounding or the symbol shown in Figure 14.1 of UL1563 is located inside the supply terminal box or compartment. To reduce the risk of electric shock, this terminal must be connected to the grounding means provided in the electric supply service panel with a continuous copper wire equivalent in size to the circuit conductors supplying this equipment.
- 17) At least two lugs marked “Bonding Lugs” are provided on the external surface or on the inside of the supply terminal box or compartment. To reduce the risk of electric shock, connect the local common bonding grid in the area of the swim spa to these terminals with an insulated or bare copper conductor not smaller than No. 6 AWG.
- 18) All field-installed metal components such as rails, ladders, drains or other similar hardware within 3m of the swim spa shall be bonded to the equipment grounding bus with copper conductors not smaller than No. 6 AWG.

IMPORTANT SAFETY INSTRUCTIONS

READ AND FOLLOW ALL INSTRUCTIONS

CAUTION: Test the ground fault circuit interrupter before each use of the swim spa.

CAUTION: Read the instruction manual.

CAUTION: Adequate drainage must be provided if the equipment is to be installed in a pit, or equivalent.

WARNING: Water temperature in excess of 100.4°F (38°C) may be hazardous to your health.

WARNING: Disconnect the electric power before servicing.

WARNING: Children should not use swim spas or hot tubs without adult supervision.

WARNING: Do not use swim spas or hot tubs unless all suction guards are installed to prevent body and hair entrapment.

WARNING: People using medications and/or having an adverse medical history should consult a physician before using a swim spa or hot tub.

WARNING: People with infectious diseases should not use a swim spa or hot tub.

WARNING: To avoid injury, exercise care when entering or exiting the swim spa or hot tub.

WARNING: Do not use drugs or alcohol before or during the use of a swim spa or hot tub to avoid unconsciousness and possible drowning.

WARNING: Pregnant or possibly pregnant women should consult a physician before using a swim spa or hot tub.

WARNING: Water temperature in excess of 98.6°F (38°C) may be hazardous to your health.

WARNING: Before entering the swim spa or hot tub measure the water temperature with an accurate thermometer.

WARNING: Do not use a swim spa or hot tub immediately following strenuous exercise.

WARNING: Prolonged immersion in a swim spa or hot tub may be injurious to your health.

WARNING: Do not permit electric appliances (such as a light, telephone, radio, or television) within 1.5 M of this swim spa or hot tub.

CAUTION: Maintain water chemistry in accordance with manufacturer's instruction.

IMPORTANT SAFETY INSTRUCTIONS

SAVE THESE INSTRUCTIONS

READ AND FOLLOW ALL INSTRUCTIONS

Hyperthermia occurs when the internal temperature of the body reaches a level several degrees above the normal body temperature of 98.6°F (37°C). The symptoms of hyperthermia include drowsiness, lethargy, and an increase in the internal temperature of the body. The effects of hyperthermia include

- (a) unawareness of impending hazard
- (b) failure to perceive heat
- (c) failure to recognize the need to exit swim spa
- (d) physical inability to exit swim spa
- (e) fetal damage in pregnant women
- (f) unconsciousness and danger of drowning

WARNING: THE USE OF ALCOHOL OR DRUGS CAN GREATLY INCREASE THE RISK OF FATAL HYPERTHERMIA IN HOT TUBS AND SWIM SPAS.

SAVE THESE INSTRUCTIONS

BASIC INFORMATION

Congratulations on the purchase of your new swim spa. Our goal is to provide you with a warm and relaxing swim spa which incorporates a soothing water massage. In order to maximize the pleasure of your swim spa, you will need to understand how it works.

The following operating and maintenance instructions are very important and must be followed carefully. With proper care and maintenance your swim spa will provide you with years of satisfaction with minimum effort.

- The pump and heater should be operated a minimum of two hours per day for cleaning and heating.
- The length of time required to heat your swim spa to the desired water temperature will vary, depending on the air temperature, season, and wind velocity. We highly recommend using a vinyl hard cover to minimize heat loss and to protect your swim spa when not in use. Covers are available from your local Swim spa dealer.
- The replaceable filter cartridge is trouble free and easy to clean. A routine cleaning is the best practice. Make sure the pump is off, then remove the cartridge. Wash it off using a water hose with a pressure nozzle and then reassemble. This should be done on a monthly basis.
- Keep the swim spa water level 2" (5cm) above the skimmer. Never allow the water level to drop below the bottom of the skimmer opening. If the water level is too low, the skimmer will allow air into the water lines of the pump, causing it to lose its prime (water flow). Running the pump without water flow will damage the pump seal assembly and could possibly result in further equipment damage, which will not be covered under warranty.
- If your swim spa has a natural wood skirt or if you purchased a gazebo, we recommend applying a wood sealer of your choice (always follow application instructions) to protect the finish. Repeat as directions suggest.
- You should clean your swim spa at least every 3-4 months. Drain the swim spa water and use a gentle liquid cleanser. DO NOT use hard brushes or abrasive cleaners. Fill with regular tap water and chemically treat the water for a clean and healthy swim spa.



CAUTION!

CAUTION: Cover must be kept on swim spa at all times when swim spa is drained or winterized. Direct exposure to sunlight can damage plastic parts and interior surface, jets, or any interior components. Damage caused by exposure to the sun will not be covered under warranty.



WARNING!

Do not use soft water. It may harm your acrylic.

SET-UP & DELIVERY GUIDELINES

GETTING READY FOR DELIVERY & SET-UP OF YOUR NEW SWIM SPA

Surface And Pad Requirements

- The swim spa, must be fully supported over the entire base. A typical installation on soil that will support 1,000 psi load, is a 5 inch (13cm) thick concrete with #4 rebar on 18 inch (46cm) centers. Condition at the site will determine the exact support requirements. Please contact your local contractor for adequate installation. Damages caused by inadequate support will not be covered by the warranty.
- If your swim spa is located near sprinklers, adjust or cap them so they do not hit the siding of the swim spa.

Balconies And Deck Requirements

- **DO NOT PLACE ANY SWIM SPA ON ANY DECK OR BALCONIES.**
- Gates must be self-closing and self-latching.

Access

- All debris blocking access to the job site must be removed prior to delivery. Any trimming of trees or bushes, removal of debris, leveling of ground or other general maintenance must be done prior to delivery and is the responsibility of the customer.

Electrical Requirements

- Your 220 Volt swim spa pack will require a double pole 60 amp dedicated GFCI (unless noted for your setup), ground fault circuit breaker. **The 19' Swim Spa requires 2 (TWO) 60AMP Circuits**
- Extension cords are not to be used in conjunction with operation of the swim spa. Low voltage damage could result, which is not covered by warranty.
- If you have any doubts, have your electrical system checked by a licensed electrician.

**NOTICE: 19' SWIM SPA
ELECTRICAL REQUIRES
2 (TWO) 60 AMP CIRCUITS**

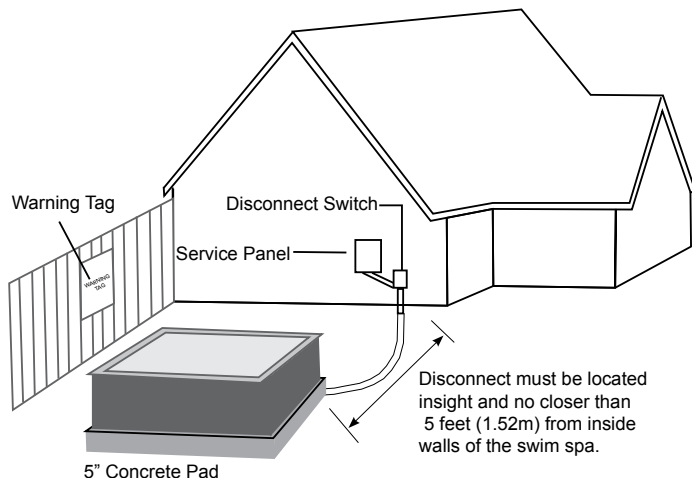

⚠ NOTE!

It is the customer's responsibility to acquire necessary permits and to arrange for installation and hook up of the electrical power by a licensed electrician.

SET-UP & DELIVERY GUIDELINES

GETTING READY FOR DELIVERY & SET-UP OF YOUR NEW SWIM SPA

GENERAL CONSIDERATIONS FOR OUTDOOR INSTALLATION

Proper planning will increase your total enjoyment factor with your new swim spa. Listed below are some additional items to consider when planning your installation.

- How swim spa will complement landscaping and vice versa.
- View from inside of swim spa and view of swim spa from inside the home.
- Exposure to sunlight and shading from trees.
- Privacy
- Getting to swim spa from house and return.
- Proximity to dressing room and bathrooms
- Storage for swim spa chemicals
- Local building codes (if applicable)
- Power cable

GENERAL CONSIDERATIONS FOR INDOOR INSTALLATION

Installing your swim spa indoors creates an extremely different set of considerations. Here again, with proper planning, no matter what room your swim spa goes in, it will be your favorite room.

- Work with your swim spa dealer and contractor to insure all local building, electrical and plumbing codes are met.
- Plan for a floor drain to drain off excess water or for draining and cleaning your swim spa.
- A ventilation fan may be necessary due to high humidity created by your swim spa.
- Finished material in your swim spa room should also be capable of withstanding increased humidity.

Excess water. Normal use if the swim spa causes large amounts of water to splash out of the unit. Depending on the specific installation, additional provisions may have to be made for proper removal of this water.

Clearance Access: In order to better service your product, clearance for access to swim spa must be 38 inches (92cm) at equipment compartment and 24 inches (61cm) around the remaining area.

NORTH AMERICAN ELECTRICAL INSTALLATION REQUIREMENT'S

HAVE YOUR ELECTRICIAN READ THE FOLLOWING INFORMATION BEFORE INSTALLATION BEGINS

Electrical connections made improperly, or the use of wire incorrectly sized, may continually blow fuses in the electrical equipment box, may damage the internal electrical controls and components. Any of these conditions may be unsafe and will void the warranty.

It is the responsibility of the swim spa owner to ensure that electrical connections are made by a qualified electrician in accordance with the National Electrical code and any local and state electrical codes in force at the time of installation.

These connections must be made in accordance with the wiring diagrams found inside the control box. This equipment has been designed to operate on 60Hz, alternating current only, 240 volts are required. Make sure that power is not applied while performing electrical installation. A copper bonding lug has been provided on the electrical equipment pack to allow connection to local ground points. The ground wire must be at least 4 or 6 AWG copper wire and must be connected securely to a grounded metal surface such as a cold water pipe. The electrical supply for your swim spa must include a 60 AMP switch or circuit breaker to open all non-grounded supply conductors to comply with section 422-20 of the National Electrical Code. This disconnect must be readily accessible to the swim spas occupants, but installed at least five feet from the swim spa but within sight. A ground fault circuit interrupter (GFCI) must be used to comply with section 680-42 of the National Electrical Code. A GFCI is designed to automatically shut off power to a piece of equipment when a ground fault is detected.

Power hook-up to the swim spa must be a 240 volt 3 wire plus ground (6 AWG copper).

Route the cable into the equipment area for final hookup to terminals inside the control panel. The swim spa must be hooked up to a “dedicated” 240 volt, 60 amp breaker and GFCI. The term “dedicated” means the electrical circuit for the swim spa is not being used for any other electrical items (patio lights, appliances, garage circuits, etc.) If the swim spa is connected to a non-dedicated circuit, overloading will result in “nuisance tripping”, which requires resetting of the breaker switch located in the house main electrical panel.

EUROPEAN ELECTRICAL INSTALLATION REQUIREMENT'S

HAVE YOUR ELECTRICIAN READ THE FOLLOWING INFORMATION BEFORE INSTALLATION BEGINS

Electrical connections made improperly, or the use of wire incorrectly sized, may continually blow fuses in the electrical equipment box, may damage the internal electrical controls and components. Any of these conditions may be unsafe and will void the warranty.

It is the responsibility of the swim spa owner to ensure that electrical connections are made by a qualified electrician in accordance with the National Electrical code / IEC and any local and state electrical codes in force at the time of installation.

These connections must be made in accordance with the wiring diagrams found inside the control box. This equipment has been designed to operate on 50Hz, alternating current only, 230 volts are required. Make sure that power is not applied while performing electrical installation. A copper bonding lug has been provided on the electrical equipment pack to allow connection to local ground points. The ground wire must be at least 10 AWG copper wire and must be connected securely to a grounded metal surface such as a cold water pipe. The electrical supply for your swim spa must include a 32 AMP switch or circuit breaker to open all non-grounded supply conductors to comply with section 422-20 of the National Electrical code / IEC. This disconnect must be readily accessible to the swim spas occupants, but installed at least five feet from the swim spa but within sight. A ground fault circuit interrupter (GFCI) must be used to comply with section 680-42 of the National Electrical code / IEC. A GFCI is designed to automatically shut off power to a piece of equipment when a current fault is detected.

Power hook-up to the swim spa must be a 230 volt 4 wire plus ground (10 AWG copper) (Where 3 phase power is used)

Route the cable into the equipment area for final hookup to terminals inside the control panel. The swim spa must be hooked up to a "dedicated" 230 volt, 32 amp breaker and GFCI. The term "dedicated" means the electrical circuit for the swim spa is not being used for any other electrical items (patio lights, appliances, garage circuits, etc.) If the swim spa is connected to a non-dedicated circuit, overloading will result in "nuisance tripping" which requires resetting of the breaker switch located in the house main electrical panel.

(YE) WIRING DIAGRAMS

Electrical wiring: North American model in.ye

Refer to wiring diagram in the enclosure box lid for more information.

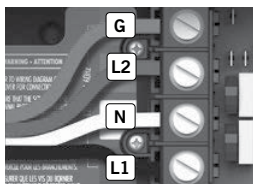

240 V (4 wires)

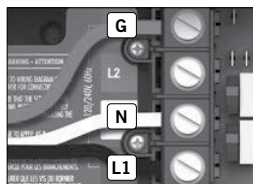

120 V (*3 wires)

* If connected to a 3 wires system, the heat.wave and accessories will not operate at 240 V.

Note: To convert model to a 120 V system, white cables from the AMP connectors and from all accessories must be shunted. See wiring diagram for details.

Refer to the section
« Connections for 120 V heaters ».

Insert each wire into the appropriate socket of the main entry terminal block according to the color code indicated on the sticker. Use a flat-head screwdriver to tighten the screws on the terminal (please refer to the sticker inside the casing to see the torque to apply).

After making sure wires are securely connected, push them back into the box and replace the cover. Do not over tighten cover screws (torque to 8 in. lb max {0.9 N.m}).

Connect the bonding conductor to the bonding lug on the front of the spa pack (a grounded electrode conductor should be used to connect the equipment grounding conductors).

NOTE!

Note: Connection order may vary by pack model, please refer to equipment pack panel for proper connection order.

(YE) WIRING DIAGRAMS

Electrical wiring: European model in.ye

Refer to wiring diagram in the enclosure box lid for more information.



Warning

in.ye.ce models must always be connected to a circuit protected by a Residual-Current Device (RCD) having a rated operating residual-current not exceeding 30 mA.

Correct wiring of the electrical service box, RCD, and pack terminal block is essential!
Check your electrical code for local regulations. Only copper wire should be used, never aluminum.

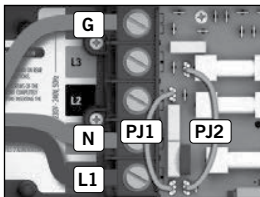

1-phase

Connect PJ1 between P37 and P49.

Connect PJ2 between P50 and P26.

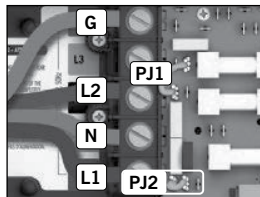

2-phase

Connect PJ1 between P37 and P26.

Connect PJ2 between P50 and P49.

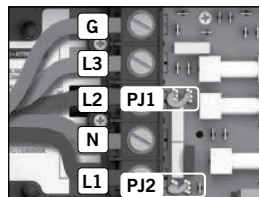

3-phase with single neutral

Connect PJ1 between P37 and P38.

Connect PJ2 between P50 and P49.

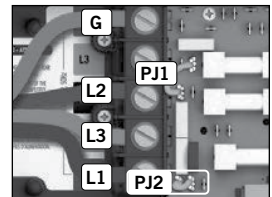

3-phase Delta (no neutral)

Connect PJ1 between P37 and P26.

Connect PJ2 between P50 and P49.

input voltage: 230V, 50Hz (Line-to-Neutral)

**Only for countries where
Line-to-Line input voltage:
230V, 50Hz.**

Insert each wire into the appropriate socket of the main entry terminal block according to the color code indicated on the sticker. Use a flat-head screwdriver to tighten the screws on the terminal (please refer to the sticker inside the casing to see the torque to apply).

After making sure wires are securely connected, push them back into the box and replace the cover. Do not over tighten cover screws (torque to 8 in. lb max {0.9 N.m}).

Connect the bonding conductor to the bonding lug on the front of the spa pack (a grounded electrode conductor should be used to connect the equipment grounding conductors). Bonding conductor must meet local electrical code.

(YE) WIRING DIAGRAM

THE DIAGRAM IS INTENDED FOR THE XE PACK SYSTEM

Wiring Requirements

- 2-Hots, 1-Neutral, 1-Isolated Ground
- 0-40' length, 4 Wire #6 AWG minimum 75°C copper conductor
- Over 40' length, 4 Wire #6 AWG minimum 75°C copper conductor

Please Note: Electrical codes vary. Please check your local requirements for the required wire size when using the 60 A GFCI Circuit

Factory Recommended G.F.C.I. Load Center Wiring



NOTE!

Note: The white neutral wire from the back of the GFCI **MUST** be connected to an incoming line neutral. The internal mechanism of the GFCI requires this neutral connection. The GFCI will not work without it.

NOTICE:
19' SWIM SPA
ELECTRICAL
REQUIRES
2 (TWO) 60 AMP
CIRCUITS

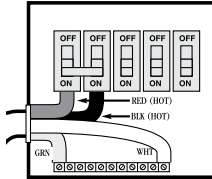

(Check your local Electrical codes for 60 Amp GFCI circuits for correct wire size for some areas vary)

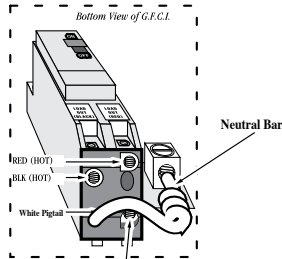

(White Wire To the Spa)

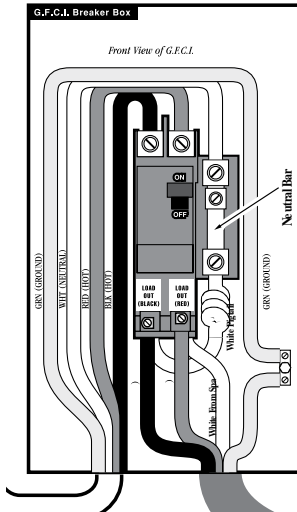

To: Spa

For Swim spa Wiring Configuration please refer to page 23 or equipment pack for detailed information



NOTE!

Note: Connection order may vary by pack model, please refer to equipment pack panel for proper connection order.

GENERAL PRE-OPERATION INSTRUCTIONS

PRIMING PUMP FOR ELECTRIC PACKS

The power pack system is located under the skirting. The equipment can be serviced by simply removing the door. The door is located on the side of the swim spa where three panels are located, usually on the side of the swim spa with the lounger, or the side where the topside control panel is located.

It is important to make sure that all of the air is out of the pump(s) before operating. To do this follow procedures below:

- Turn off power at the breaker
- Make sure the gate valves are open
- Fill the swim spa with water going thru the filter
- Turn the power on at the breaker
- Start the pump on low speed and water should start circulating within one to two minutes. If water does not start circulating, turn pump from low to high until prime is picked up.
- If pump still does not prime, please see “Trouble Shooting Guide” located in the back of this manual



NOTE!

Note: Equipment style and location will vary by model

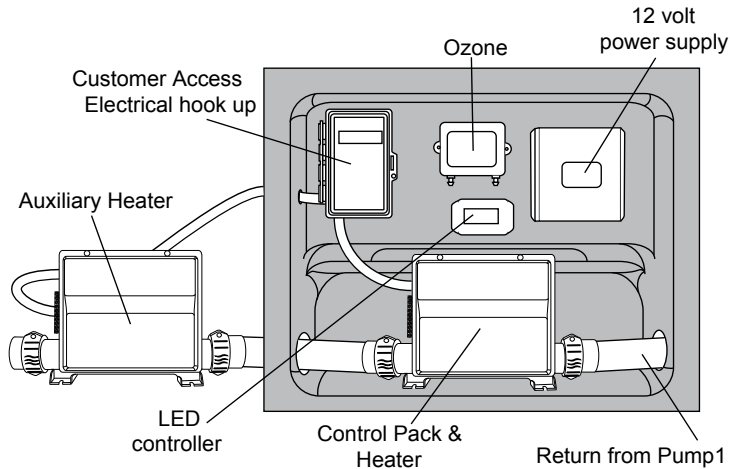

Set thermostat, located on top side control panel, to desired temperature and continue heating until desired temperature has been reached. Depending on equipment, this will normally take 8 to 10 hours.



WARNING!

WARNING: Do not run swim spa with gate valves closed or run pump with no water circulating in swim spa for long periods. This could damage the swim spa equipment.

SWIM SPA TERMINOLOGY

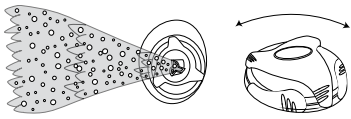

JETS:

Your new swim spa features a variety of jet styles. All jets regardless of style return the water to the swim spa. Air is mixed with the water by using the air controls (if equipped) creating a gentle to most vigorous massage.

WATER DIVERTER VALVE

The water diverter valve controls the output of the pump(s) water flow to either side of the swim spa. It will provide even water flow to all jets if left in the half way position. The purpose of this valve is to increase or decrease the output of one side or another for maximum or minimum water flow in case of one or two person usage. This valve is also used to turn the master massage jet on and off, if so equipped. Colors/style may vary from drawing. A water diverter valve is the largest of the valve controls.

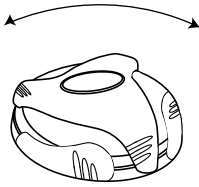

FOUNTAIN JET CONTROL

If your swim spa is equipped with optional fountain jets, they are controlled with a fountain jet control. Turning the fountain jet control full counterclockwise will turn the fountain jet on full power, while turning full clockwise will turn the fountain jet off.

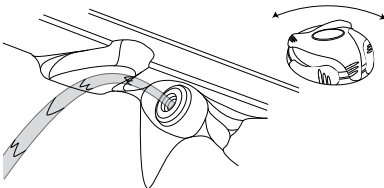

WATERFALL CONTROL

If your swim spa is equipped with waterfalls, they are controlled with a mini diverter valve. Turning the mini diverter valve full clockwise will turn the waterfall on full power, while turning full counterclockwise will turn the waterfall off.

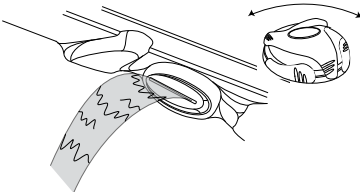

AIR CONTROL

Each swim spa is equipped with air controls (venturies). The purpose of these controls is to regulate the mixture of air and water that flows through the jets. If an optional blower is installed, air is also pushed through the air controls (venturies) for maximum output. If your swim spa has a master massage jet located in the foot well, the swim spa will be equipped with an air control specifically for the master massage jet. This third control operates the same as the others. Colors/style may vary from drawing. An air control is the smallest of the valve controls.

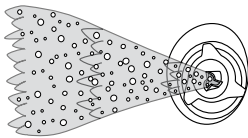

Although all three controls look similar in appearance, they are easily discernible by size. The air control is the smallest, the mini diverter valve is medium in size, and the water diverter valve is the largest .

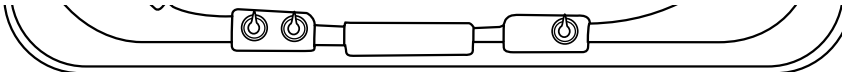

Mini Diverter Valves, Air Controls, and Water Diverter Valves location, size and design will vary on each swim spa model.

SWIM SPA TERMINOLOGY

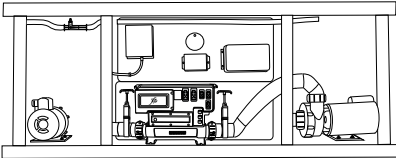

EQUIPMENT ACCESS PANEL:

This area is located behind the side panel below the topside control panel, this houses the major components responsible for the operation of the unit. The components include pumps, heater, control panel box, ozonator, and led light system (if applicable). Pump and equipment placement may vary by model.

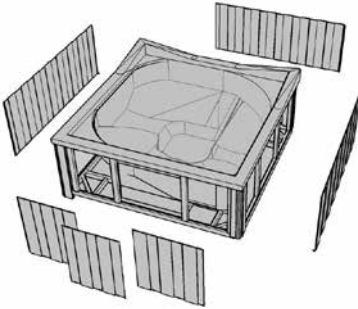

ACCESS PANELS

These are located on all four sides of the swim spa. All of the panels are removable for service purposes



OR



Swim spa LIGHT

Your swim spa light is designed for safety and is located in the interior wall of your swim spa. The on/off switch is located on the topside control panel.

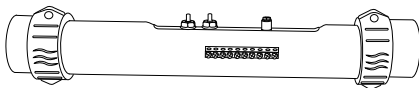

XE - PACK

Swim spa HEATER

This element is an electric heater housed in a stainless steel tube. It is thermostatically controlled and equipped with a high-limit temperature safety shut-off sensor. The high-limit sensor cannot be reset until the temperature within the heater assembly drops several degrees below the shut-off temperature of 100° (varies by model). Should the high-limit switch trip repeatedly, contact your dealer or qualified service representative to diagnose the problem.

SWIM SPA TERMINOLOGY

GATE VALVES

Are installed for shut off/on water supply from heater or pump for service. For normal swim spa operation valves should be in the open position (handle extended is open).

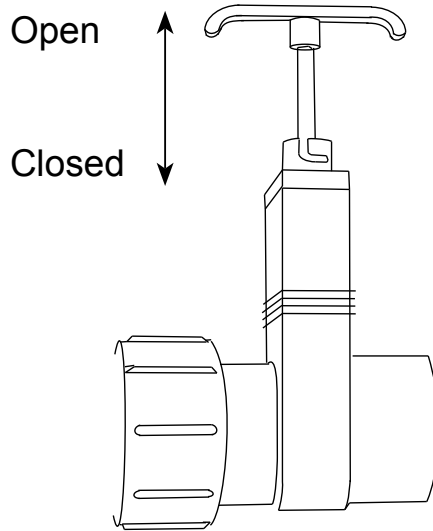

MAIN PUMP

This produces water flow through heater and main jets. Also used for filtration. Can be controlled as desired by pressing the pump or pump 1 button on your topside control panel. Refer to quick reference card for filtration frequency and duration.

SECONDARY PUMP (on select models)

This produces water flow through secondary group of jets. Can be controlled by pressing the pump 2 button on your topside control panel.

THIRD PUMP (on select models)

This produces water flow through third group of jets. This pump will be a high speed only. Can be controlled by pressing the pump 3 button on your topside control panel.

CIRCULATION PUMP (on select models)

If equipped, this pump is controlled during filtration and heating only, by the topside control configuration. Refer to quick reference card for filtration frequency and duration.

OZONATOR (on select models)

If equipped, will run for 45 minutes during filtration cycle. Helps reduce chemicals/santizier use. Automatically cuts-off if any user buttons are pressed on topside control; will reactivate during the filtration cycle.

FILTER LOCATION

Filter Location (Location varies by model)

13' Party, 13', 14', 16', 17' & 19' models are equipped with open style filters

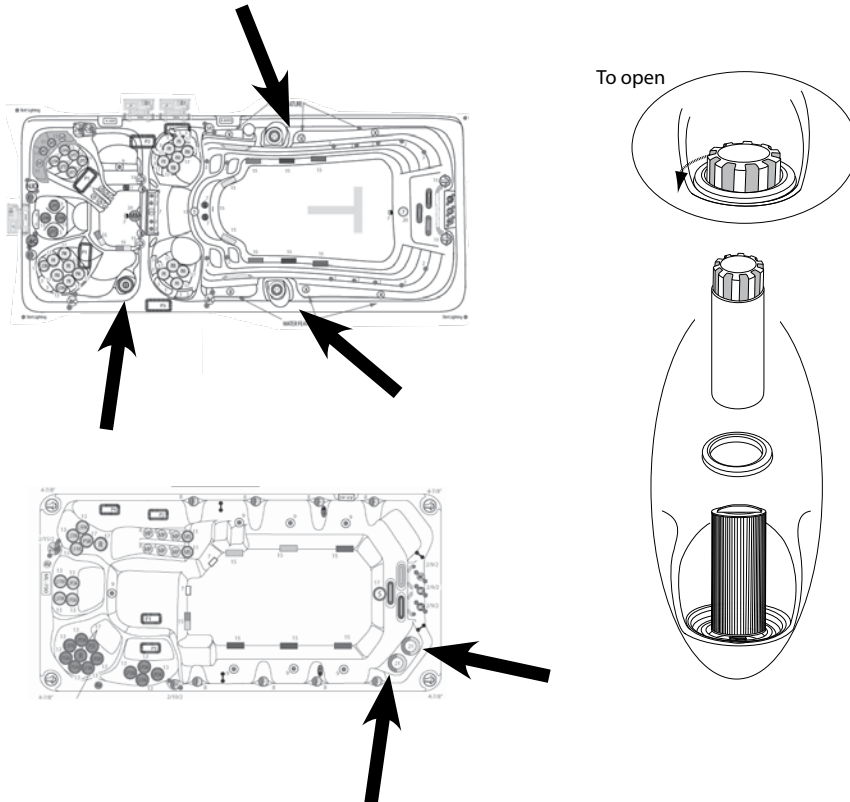

Filter Maintenance

Filtration starts as soon as water flow is steady through the filter. The filter cartridge removes body oil and debris from the swim spa water. A dirty cartridge will decrease flow and may prevent the swim spa from heating properly. Therefore, regular filter cleaning is essential.

Cleaning and Replacing Filter Cartridge

Your swim spa filter(s) have been designed for quick and easy maintenance.



NOTE!

Note: The filter location may vary.

Note: The filter should be inspected and cleaned on a regular basis.

FILTER LOCATION

12' model is equipped with enclosed style filter

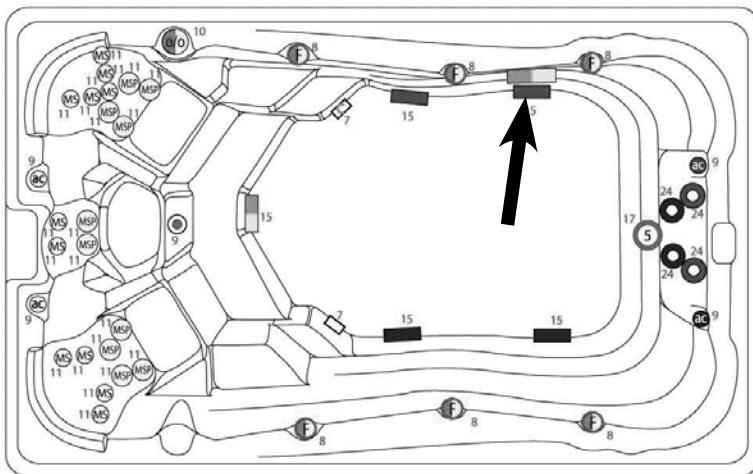

Enclosed Style

- Turn off power at the breaker.
- Pull the top floating weir assembly out exposing the filter.
- Unscrew filter cartridge(s) and remove.
- Clean with a garden hose equipped with a high pressure nozzle, or soak in filter cartridge cleaner if necessary, or at every other regularly scheduled cleaning. Rinse filter thoroughly before installing.
- Screw clean cartridge back into filter enclosure and return filter door to original position.



NOTE!

Note: The filter should be inspected and cleaned on a monthly basis.

TOPSIDE CONTROLS

List of compatible keypads for the Y series control system



in.k450 main keypad

LCD display, 7 keys



in.k1000 main keypad

Color LCD capacitive
touchscreen display



NOTE!

Note: Please refer to your Quick Reference Guide / Card for programming and general operating instructions for your specific control pad.

WATER CARE

Cleaning Your Swim Spa Water

You need to keep your swim spa clean and ready to use. When you enter your swim spa, you bring in as much contamination as 50 people would in a normal size swimming pool! Because your swim spa is such a small, enclosed environment, it needs to be a sanitary place. We accomplish this with a simple three step process:

- Balance
- Filtration
- Sanitation

The water that comes from your tap at home is fine for showers or bathing, because it is drained immediately after use. In a swim spa, your water is used for up to three months. Hot water is a breeding ground for bacteria, so sanitizing becomes necessary, as well as maintaining a specific mineral balance. Having that mineral balance in place ensures that the water, which is naturally corrosive to metal, will not cause damage to the swim spa equipment. We recommend weekly water testing.

WARNING!

WARNING: Maintain water chemistry in accordance with manufacturer's instructions.

WARNING!

WARNING: Please be careful with chemicals - damage to the surface of the swim spa can occur due to the improper use of chemicals such as trichlor or chlorine, chemical tablets, acids or swim spa cleaners. Do not let undissolved chemicals lie on the surface of the swim spa. Damage from chemical misuse is not covered under warranty. Improper water chemistry balance can damage the swim spa surfaces and/or equipment, and is not covered under your warranty.

Filling Swim Spa With Water

When filling the swim spa, use 2 ounces of SODIUM BROMIDE to create a bromide reserve. When using BROMINATING TABLETS in a floating dispenser, two to three tablets will treat up to 500 gallons (1893 Liters) of water. For a chlorine system, use CHLORINATING GRANULES (1/2 oz. per 500 gallons) (1893 Liters).

Once the swim spa has been filled to the correct level and pumps are primed and running add:

STAIN & SCALE REMOVER- This prevents staining, rust and corrosion, caused by metals in the source water. One bottle will treat up to 500 gallons for up to 3 months.

CALCIUM BOOSTER (If Needed) - Calcium booster treats the water if low calcium hardness is a problem in your area. It will help prevent equipment corrosion and foaming by raising the swim spa's water hardness level to an acceptable range of 120 ppm.

pH STABILIZER - It will properly adjust and hold the pH for up to 3 months.

Water Testing

Your Swim spa Dealer is equipped to perform a thorough analysis of your swim spa water. Take a one liter sample to the store and they will advise you on the products necessary to properly balance and care for your swim spa. Unbalanced swim spa water can quickly damage your equipment. Your Swim spa Dealer will advise you on how to protect your investment.

WATER CARE

Balance

Swim spa water must have the correct chemical balance. Unbalanced water can irritate eyes, corrode the equipment, leave mineral deposits, and decrease the effectiveness of the sanitizer. Balanced water means establishing proper balance among Total Alkalinity, pH, Calcium Hardness and Total dissolved solids.

(AN OVERVIEW)

Monthly - For Equipment Protection

CALCIUM BOOSTER (If Needed) - Calcium booster treats the water if low calcium hardness is a problem in your area. It will help prevent equipment corrosion and foaming by raising the swim spa's water hardness level to an acceptable range of 120 ppm.

Filter Cleaning

Keep your filter free of grease, grime, and oil. Clean the filter with Swim spa **CARTRIDGE FILTER CLEAN**. One 16 oz. bottle treats a 55' filter (1525cm). See Filter Maintenance section for location and diagram.

AS NEEDED

Surface Cleaning

Between refills and as needed, clean the surface using Swim spa **MULTI-PURPOSE CLEANER**. For tough scale & stains, use **STAIN & SCALE REMOVER**.

Surface Protection

To protect and seal the swim spa surface, use Swim spa **FAST GLOSS** every time you drain and clean the swim spa.

Water Balance

Adjust the pH quickly and easily with **pH STABILIZER**. It will properly adjust and hold the pH for up to 3 months. Note: Not recommended for calcium hardness levels above 200 ppm. Use Swim spa **UP** to raise pH and Swim spa **DOWN** to lower pH.

Sanitizing

Use 2 ounces of **SODIUM BROMIDE** to create a bromide reserve. When using **BROMINATING TABLETS** in a floating basket, two to three tablets will treat up to 500 gallons (1893 Liters) of water. For a chlorine system, use **CHLORINATING GRANULES** (1/2 oz. per 500 gallons) (1893 Liters).

Mineral Protection

STAIN & SCALE REMOVER - This prevents staining, rust and corrosion, caused by metals in the source water. One bottle will treat up to 500 gallons (1893 Liters) for up to 3 months.

Foam Control

To control foaming, use Swim spa **FOAM DOWN**. For added convenience, use just 3 drops of Swim spa **FOAM DOWN CONCENTRATE**.

Skin Conditioning

To prevent dry skin, pour **SKIN SOFTENER** directly into the swim spa. It soothes and moisturizes.

Algae Control

For swim spas with green or yellow algae, use Swim spa **ALGAECIDE** to kill and prevent further algae growth.

SWIM SPA WATER MAINTENANCE

Problem	Possible Cause	Action
Cloudy Water/Haze	Total alkalinity in high range.	Add alkalinity decreaser (acid). Target 100.
	pH too high or too low.	Sprinkle or pour pH adjuster.
	Too little sanitizer in water.	Test and adjust pH & sanitizer to range.
	Fine particles won't filter out.	Add flocculant to skimmer, run pump, then remove & clean filters.
	Circulation Restricted Pump sucking air.	Check skimmer basket; clean. Make sure intakes are open.
	Filter dirty.	Hose off filter: check for tears, fiber breakdown, clogging or collapse: replace.
	Filter cycle too short.	Run filter system 24 hours & reclean and/or run main pump longer each day.
	Total dissolved solids have reached chemical saturation point.	Test TDS at dealer. Drain and refill swim spa.
Foam	White chips scaling off heater: Calcium level too high.	Drain and inch of water off, add fresh water. Test and adjust calcium to range. Add sequestering agent.
	Air leaking into filter system.	Find and fix leaks; use a pro if necessary. Raise water level above the skimmer opening.
	Detergent in water via soap in swimming suit, or on bathers' body and hair.	Advise swim spa users to rinse soap off more thoroughly in the shower before getting into swim spa. Double rinse bathing suits. May be less effort to drain and refill the swim spa.
	Too little hardness in water.	Add calcium to correct level.
Discolored Water	Too much sanitizer in water. Too much algaecide in water.	Remove some water and add new. Retest. Empty out some water and add fresh.
	If foam is still present.	Squirt defoamer over the water surface.
Discolored Water	Green water due to copper getting into water: or MPS (monopersulfate compound) getting into biguanides	Add sequestering or chelating agent. If MPS and biguanides mix, do a major flush.
	Too much bromine.	Leave off cover so bromine dissipates more quickly.
Staining	Possible algae: yellow-green. pink, brown, or black.	Treat with algaecide. Worse cases, tetraborates.
	Minerals such as copper or iron making green or brown stains	Add sequestering or chelating agent.
Odor	Bromamines or chloramines from non-oxidized organic mater.	Shock with non-chlorine oxidizer such as potassium peroxymonosulfate.
	Moldy dirty cover either inside or out.	Clean cover both inside and out with diluted bleach.

⚠ WARNING!

Do not leave your water treatment products outside. If subjected to extreme heat or cold, their effectiveness can be impaired. KEEP ALL CHEMICALS OUT OF THE REACH OF CHILDREN!

**EXERCISE
EQUIPMENT
INSTALLATION**

**Swim spa
Exercise Equipment**



1 - Zipper Bag



**2 - 10" Bands
2 - 10 1/2" Bands
2 - 56 1/2" Bands**

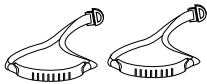

2 - Hand Grips

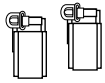

2 - Ankle Straps

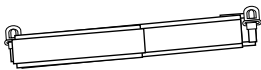

1 - Waist Band

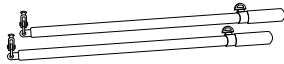

2 - Oars

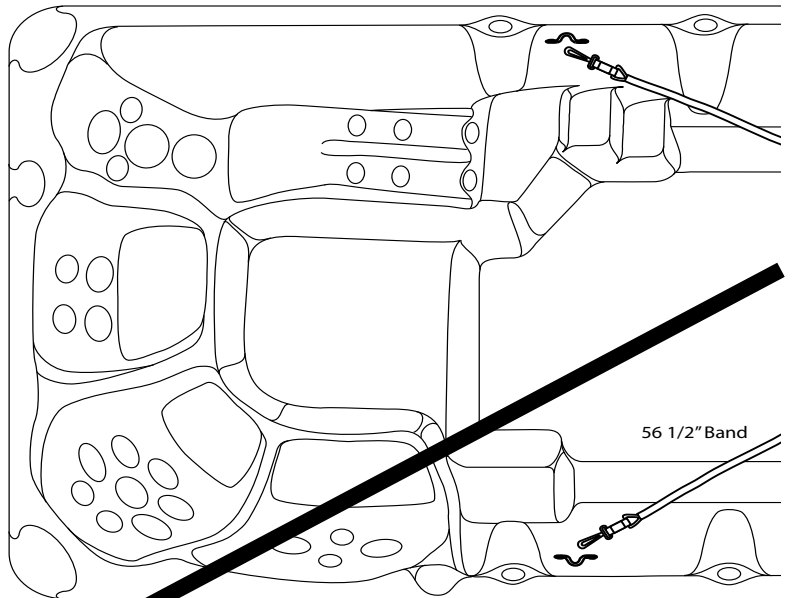
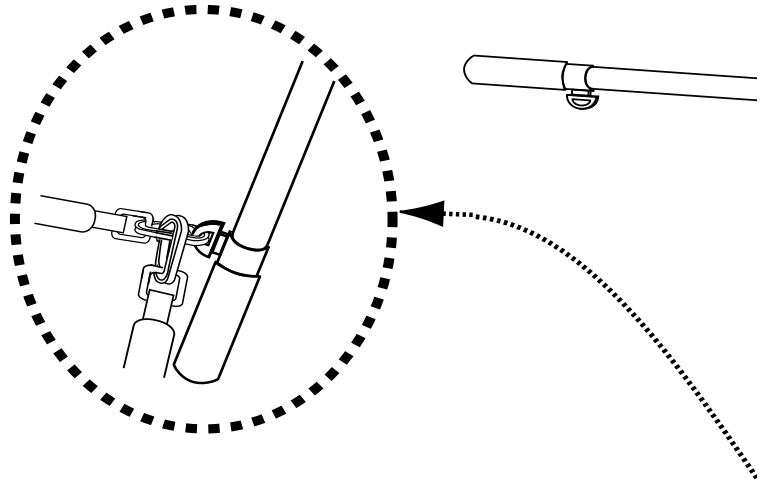

Please refer to Drawing



NOTE!

**THIS EXERCISE EQUIPMENT APPLIES TO THE HOOK-UP
OF THE 16', 17' & 19' Swim spa.**

SCHEMATIC

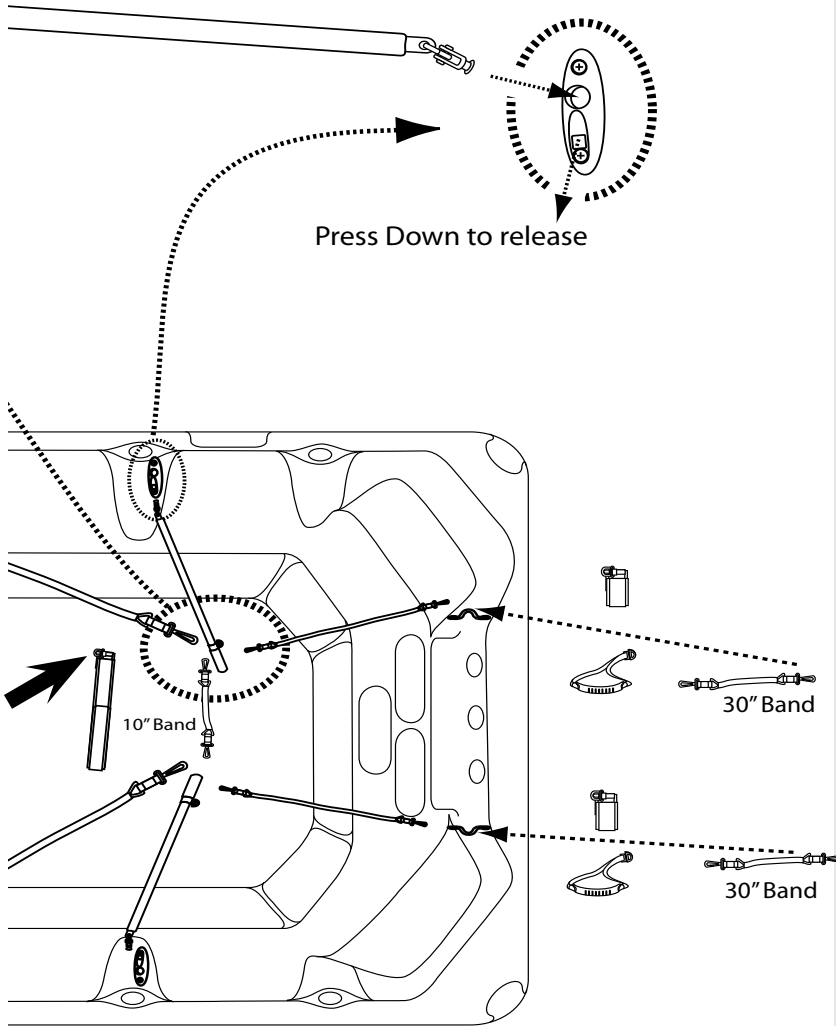

WARNING SIGNS

DANGER SIGN

Every swim spa has a warning sign that outlines safety precautions. Read and familiarize yourself with all warnings listed on this sign. Make the sign visible and accessible to all swim spa users.

NO CLIMBING OR WALKING ON TOP RAIL

⚠ DANGER

**SHALLOW WATER
NO DIVING - NO JUMPING
DIVING OR JUMPING MAY CAUSE DEATH, PARALYSIS OR PERMANENT INJURY**

**FAILURE TO FOLLOW THESE RULES
MAY CAUSE DEATH, PARALYSIS OR PERMANENT INJURY**

HOW TO PREVENT DIVING/JUMPING ACCIDENTS

- This is a non-diving pool/spa system.
- Do not dive or jump into the pool/spa under any circumstances.
- Do not utilize sliding equipment with this pool/spa system.
- Do not utilize diving equipment with this pool/spa system.

HOW TO PREVENT CHILD DROWNING ACCIDENTS

- Children must be constantly and closely supervised when using the pool/spa system.
- Children must not be allowed in the pool/spa system area without an adult being present.
- The pool/spa system cover must be closed and locked when the pool/spa system is not being used.
- Portable ladders must be removed when not in use.
- Limited access ladders must be removed or latched in the raised position when not in use.

HOW TO PREVENT OTHER ACCIDENTS

- Do not swim alone.
- Do not use the pool/spa system if you have taken drugs or consumed alcohol.
- Non-swimmers must stay in the shallow end of the pool/spa system.

For additional information please read the safety and usage information located in the Inside-Cover manual.

EMERGENCY PHONE NUMBER

NO DIVING

**SHALLOW WATER • NO JUMPING
DIVING OR JUMPING MAY CAUSE DEATH, PARALYSIS
OR PERMANENT INJURY**

NO CLIMBING OR WALKING ON TOP RAIL

⚠ NOTE!

DRAWING MAY VARY - MANUFACTURER HAS RESERVED RIGHTS FOR ANY CHANGES OR MODIFICATIONS.

SWIM SPA EXERCISE SUGGESTIONS

- Suggested Uses -

Rowing Equipment

Here's another terrific workout with virtually no impact on your joints that's easy to use.

Many people think this machine is only good for the upper body, however that's not true. Rowing targets both the upper and lower body muscles. To get started, grab the handle and adjust your stance until your legs are bent a little more than 90 degrees and your arms are straight out in front of you. Now pull the handles toward your chest, but keep the handle just below chest level. Your elbows should be tucked at your sides, not stretched out to the left and right. Also, your back should have a slight natural arch to it. Release to the starting position by straightening out your arms and bending your knees back to their original location. Congratulations! That's one full stroke. Continue with this routine, building a slow rhythm for the first three to five minutes. Slowly build up your speed at regular intervals until you reach your target heart rate.

The 30 Minute Workout

Begin with a 5-minute warm-up on a light resistance setting, rowing slowly. Concentrate on your form and get your rhythm going. Begin to build your speed and resistance to a level that puts you into your target heart rate zone. Stay in your target heart rate zone for the next 20 minutes while varying your rowing speed and resistance level. If you find you're over your target heart rate, consider rowing intervals; row for one minute, rest for one minute and so on. Gradually build up the intervals until you can row for 20 minutes straight. Periodically focus on your form during the workout to get the greatest effect. Close your eyes and transport yourself to your favorite body of water while you're rowing. The last 5 minutes are for the cool down. Gradually slow your rowing speed and reduce the resistance to a minimum. Don't stop abruptly, use this time to let your body cool off and get your heart rate down. As your heart rate begins to decrease, let go of the handles and relax while doing some slow neck and shoulder rolls. It's always a good idea to take another five minutes after the routine to stretch the same muscles again (arms, legs and chest). This will help prevent excessive soreness following the workout.

When you first start exercising with the rowing equipment, you might find that you have to pause for thirty to sixty seconds every other minute or so to maintain your target heart rate. It's important that you not over-exert yourself while you're getting used to the routine.

Hand Grips

Chest Press

Hold hand grips in both hands, tubing running along the inside of the arms (under the armpits), palms facing each other. Squeeze chest and back while pulling towards you. Return to start and repeat.

Rear Delt Row

Hold the hand grips with arms out in front, palms down. Pull the elbows back until level with torso, squeezing the shoulder blades and keeping arms parallel to ground.

SWIM SPA EXERCISE SUGGESTIONS (CONT.)

Ankle Straps

Legs, Hips, Thighs, Knees and Ankles

The ankle strap can be used to strengthen the entire lower body. It is fairly simple to use and is popular for use with men and women. Women tend to use the ankle strap to strengthen and firm the thighs and hips but especially for the buttocks. Men use the product more so for strengthening the legs.

The ankle strap is an attachment for leg pulley-type exercise work that basically falls into the cable system exercise category. It is good for working the lower body, particularly the legs. The legs can be thoroughly worked at multiple angles and can strengthen the hips, thighs, knees, and ankles.

Waist Band

Legs, Thighs, Knees and Waist

The waist band can be used to build endurance and strengthen the entire lower body. It is fairly simple to use. Clip the waist band around your waist attach the tethers to the brackets located on either side of the swim spa and walk, run in place or swim.

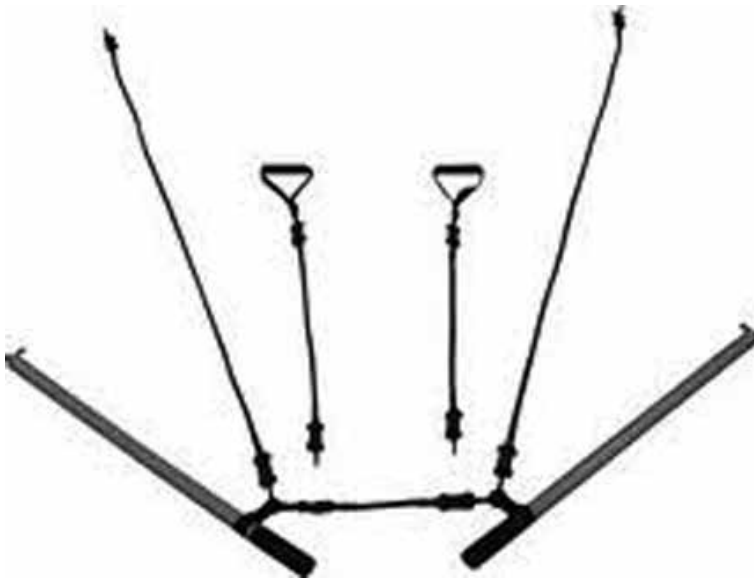

19' SWIM SPA SCHEMATIC

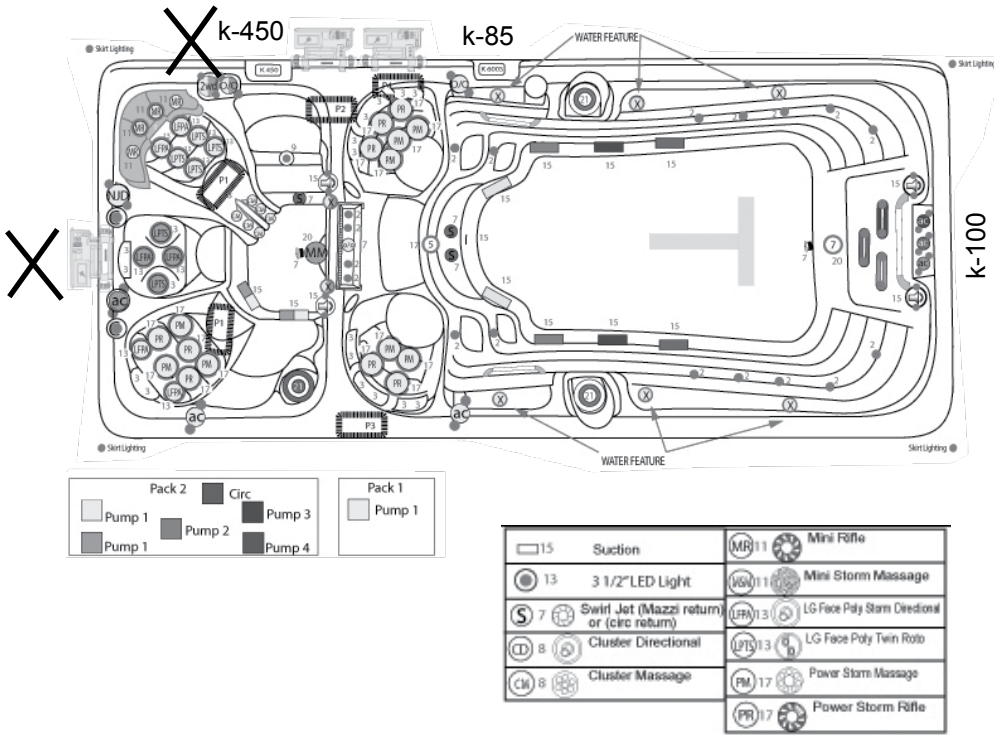

X THE X INDICATES ELECTRICAL CONNECTION(S)

NOTICE: ELECTRICAL REQUIREMENTS: 2 (TWO) 60 AMP CIRCUITS

▲ NOTE!

DRAWING MAY VARY - MANUFACTURER HAS RESERVED RIGHTS FOR ANY CHANGES OR MODIFICATIONS.

17' SWIM SPA SCHEMATIC

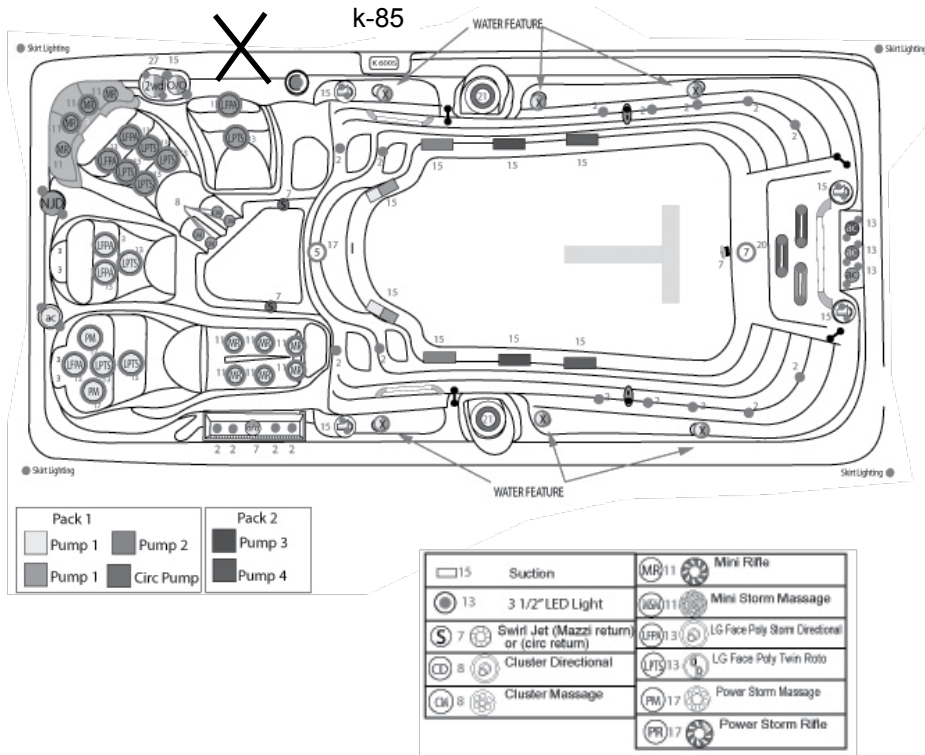

X THE X INDICATES ELECTRICAL CONNECTION(S)

**NOTICE: ELECTRICAL REQUIREMENTS:
1 (ONE) 60 AMP CIRCUIT**

▲ NOTE!

DRAWING MAY VARY - MANUFACTURER HAS RESERVED RIGHTS FOR ANY CHANGES OR MODIFICATIONS.

16' SWIM SPA SCHEMATIC

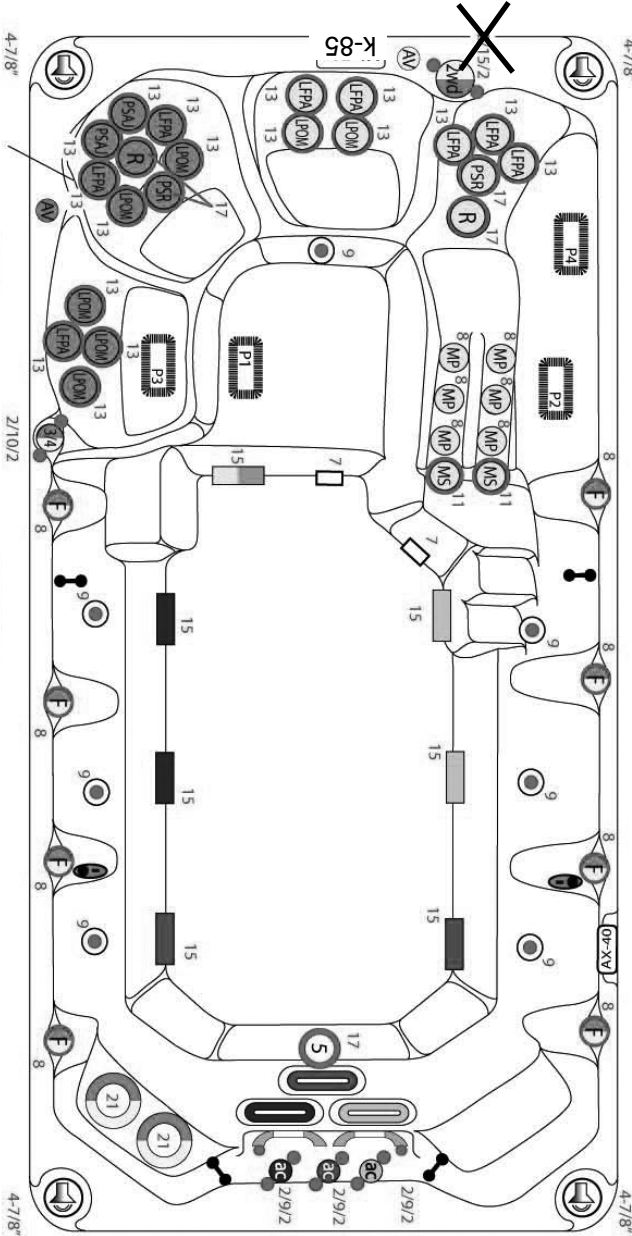

**NOTICE: ELECTRICAL REQUIREMENTS:
1 (ONE) 60 AMP CIRCUIT**

**X THE X INDICATES
ELECTRICAL CONNECTION(S)**

	Mini Storm Spinner
	Mini Storm Directional
	Master Massage
	LG Face Poly Storm Massage
	Poly Storm roto
	LG Face Poly Storm Directional
	Poly Storm Directional
	7" Cascade Waterfall
	Poly Storm Directional
	Power Storm Resonator
	Power Storm Massage
	Power Storm Spinner
	Cluster Storm Pulsator
	Adjustable Euro
	LED Lighting
	Euro
	Surface Tension (Euro)
	Adjustable Cluster
	Water Feature
	Mini Pulsator
	Drain
	2" LED Light
	5" LED Light

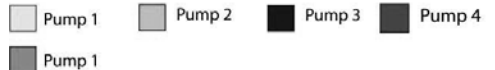

▲ NOTE!

DRAWING MAY VARY - MANUFACTURER HAS RESERVED RIGHTS FOR ANY CHANGES OR MODIFICATIONS.

14' SWIM SPA SCHEMATIC

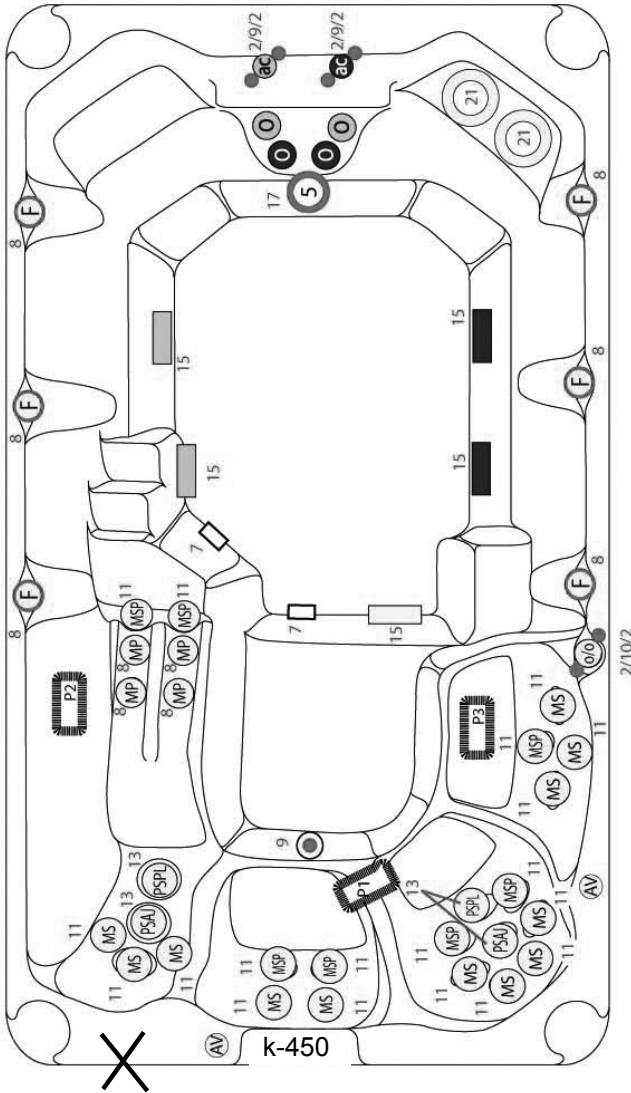

**NOTICE: ELECTRICAL REQUIREMENTS:
1 (ONE) 60 AMP CIRCUIT**

**X THE X INDICATES
ELECTRICAL CONNECTION(S)**

F 8	Water Feature
7	Drain
9	2" LED Light
5 17	5" LED Light
15	Suction
MP 8	Cluster Storm Pulsator
MSP 11	Mini Storm Spinner
MS 11	Mini Storm Directional
PSA 13	Poly Storm Massage
PSPL 13	Poly Storm Spinner
o/o 10	3/4" On / Off Valve
AV	Air Valve
O	Swim Jet
ac 9	Air control

Pump 1
 Pump 2
 Pump 3

▲ NOTE!

DRAWING MAY VARY - MANUFACTURER HAS RESERVED RIGHTS FOR ANY CHANGES OR MODIFICATIONS.

13' SWIM SPA SCHEMATIC

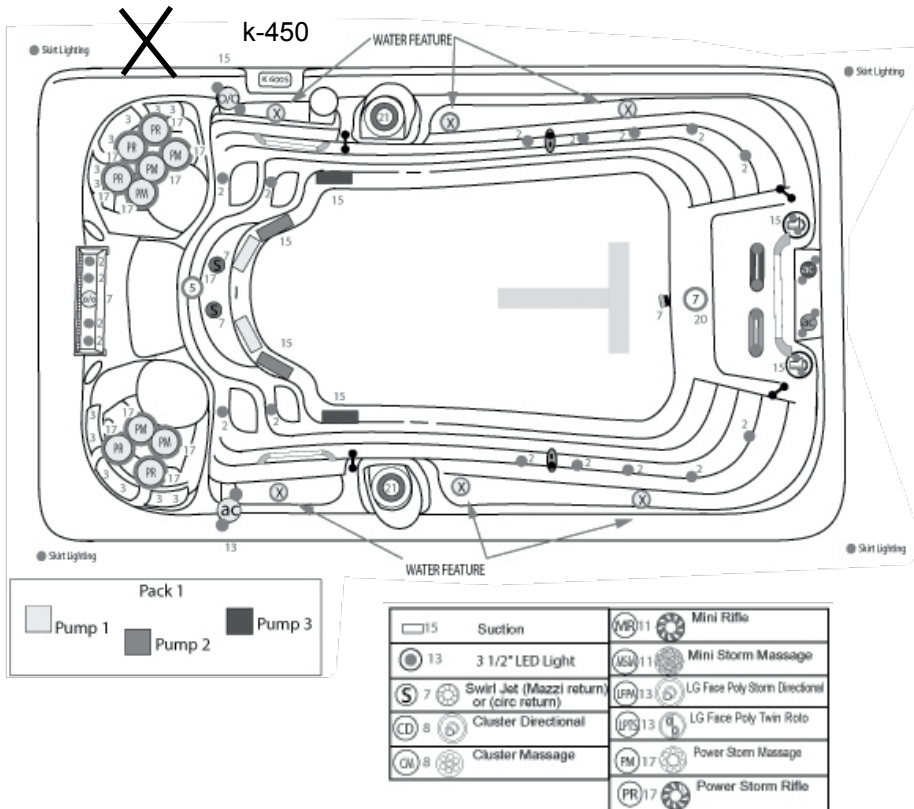

X THE X INDICATES ELECTRICAL CONNECTION(S)

**NOTICE: ELECTRICAL REQUIREMENTS:
1 (ONE) 60 AMP CIRCUIT**

▲ NOTE!

DRAWING MAY VARY - MANUFACTURER HAS RESERVED RIGHTS FOR ANY CHANGES OR MODIFICATIONS.

13' PARTY / SWIM SPA SCHEMATIC

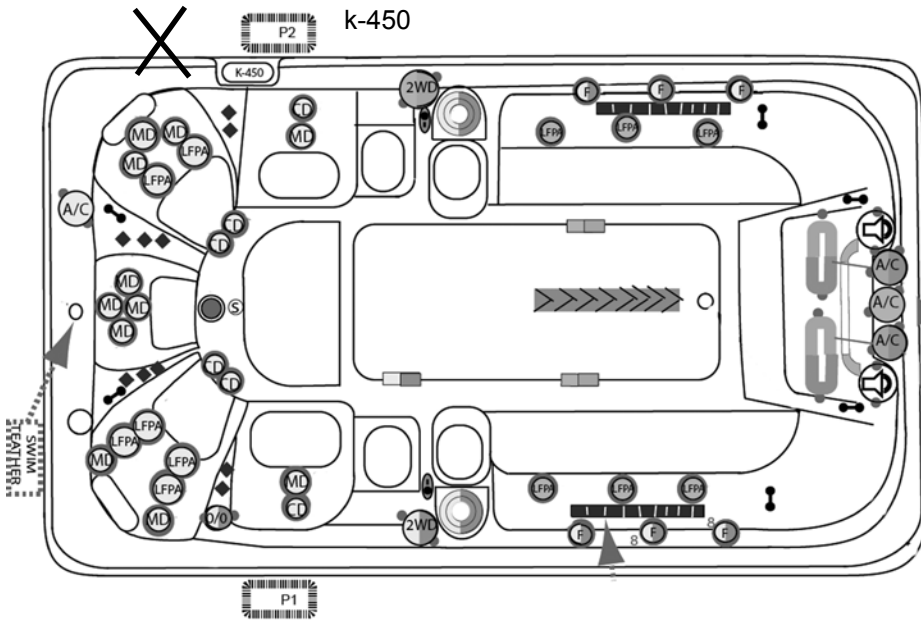

X THE X INDICATES
ELECTRICAL CONNECTION(S)

**NOTICE: ELECTRICAL REQUIREMENTS:
1 (ONE) 60 AMP CIRCUIT**

▲ NOTE!

DRAWING MAY VARY - MANUFACTURER HAS RESERVED RIGHTS FOR ANY CHANGES OR MODIFICATIONS.

12' SWIM SPA SCHEMATIC

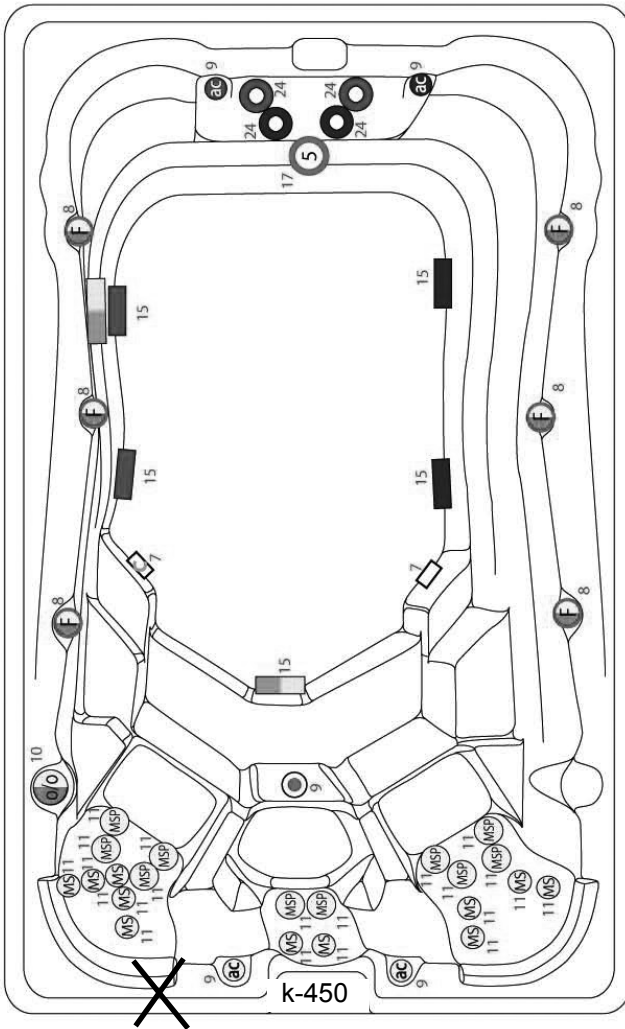

**NOTICE: ELECTRICAL REQUIREMENTS:
1 (ONE) 60 AMP CIRCUIT**

**X THE X INDICATES
ELECTRICAL CONNECTION(S)**

F 8	Water Feature
MS 11	Mini Storm Directional
MSP 11	Mini Storm Spinner
5 17	5" LED Light
7	Drain
15	Suction
o/o 10	3/4" On / Off Valve
ac 9	Air control
24	Whirl Pool Jet
9	2" LED Light

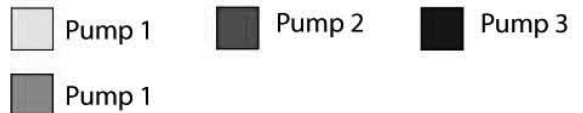

▲ NOTE!

DRAWING MAY VARY - MANUFACTURER HAS RESERVED RIGHTS FOR ANY CHANGES OR MODIFICATIONS.

GENERAL SWIM SPA MAINTENANCE

Proper Maintenance For Your Swim spa Pillows

- Your swim spa pillows need to be rinsed periodically to remove any chemical residue. This should help to eliminate pillows becoming stiff and discolored.
- If swim spa is not to be used for a period of time, pillows should be removed. Pillow life will be extended.

Proper Maintenance For Your Swim spa Fountain Jets

- In order to keep your fountain jets operating properly, follow these instructions in sequence:
- Turn off fountain jets
- Remove outer ring by turning face counter clockwise
- Remove internal jet insert with a pair of needle nose pliers.
- Clean plastic filter at the back of the jet insert so all holes are free of debris.
- Reinstall jet insert and outer ring.

Please note: We do not recommend the fountain jets be left on when swim spa cover is closed, this may damage your swim spa cover.

Proper Care For Stainless Steel Surfaces

It is possible for stainless steel to corrode under the correct adverse circumstances. It is important to maintain proper water chemistry at all times to prevent damage to the stainless steel surfaces, as well as other surfaces, and components.

Stainless steel obtains its resistance to corrosion by a thin coating over the outer surface. In the event this thin coating is damaged or removed, the surface then becomes susceptible to corrosion and rust. This coating can be damaged by the buildup of chemicals most commonly from off gassing chemicals becoming trapped between the cover and the spa water. This coating can also be damaged by using abrasive materials such as steel wool or abrasive cleaners such as household bleach.

The following steps will ensure the stainless steel maintains its resistance to corrosion and long lasting beauty.

- Ensure proper water chemistry is maintained at all times.
- Wait 15 to 20 minutes before covering the spa after chemicals have been added.
- Clean surfaces often with fresh water.
- Do not use abrasive materials or abrasive cleaners.
- If using a floater to dispense chemicals, regularly check the sanitizer levels in the spa water to ensure the floating dispenser is not allowing too much sanitizer into the water.

Failure to properly care for and maintain the stainless steel surfaces in the spa may result in rusting or showing signs of corrosion. Rusting or corrosion is not covered by the warranty.

GENERAL SWIM SPA MAINTENANCE

Proper Maintenance For Your Swim spa Surface

Quarite Plus® Disclaimer: This swim spa may be insulated with high-density urethane foam for structural support and energy efficiency. When empty of water and left in direct sunlight without the swim spa cover in place, the swim spa is vulnerable to ultra violet or solar damage. Temperatures generated by sunlight that become concentrated in the shell surface cause the shell material to delaminate from the urethane foam backing. This occurrence is considered abuse and may result in surface blisters, bubbles or large layer delamination. This occurrence is not covered under warranty. The swim spa cover must be kept on the swim spa while empty of water.

Pump and Heater Unions

- Pump unions and heater unions may need to be tightend periodically.
Loose connections are not covered under warranty

Proper Maintenance For Your Swim spa Cover

- 1) Use a soft broom to remove accumulation after every snowfall or ice storm.
- 2) Splash cool tap water on the hardware to free them if they become frozen shut. Household lubricating oil will keep the lock free, but apply carefully because it can damage the cabinet finish.
- 3) We recommend a good treatment with vinyl conditioner before the first snow or ice. If possible, treat during the winter too.
- 4) Monitor your water chemistry. Even if the swim spa is not used regularly, improper water chemistry can cause a mildew build-up on the cover. Clean, PH controlled water will prolong the life of the cover.
- 5) If mildew is found, remove foam cores from the vinyl encasement. Mix 1 gallon of water, a teaspoon of mild dish washing soap and a cup of bleach. With a soft bristle brush, scrub the inside and outside of the vinyl encasement thoroughly. Take a washcloth and wipe down each foam core; rinse thoroughly. Place the encasement in the sun and foam cores in the shade to dry. Once everything is thoroughly dry, spray the cores and encasement with a mildew inhibitor. Allow to dry completely, then reassemble. The key here, of course, is to maintain proper water chemistry to avoid mildew.
- 6) We suggest rotating the cover every six months to maintain even wear. Unzip the cover, remove the foam cores, turn over and reassemble.

**Ask Your Dealer About Using A Cover Caddy
PROTECT YOUR COVER!**

GENERAL SWIM SPA MAINTENANCE

DRAINING YOUR SWIM SPA

Because your spa holds a relatively small amount of water, contaminants such as body oil, perspiration, dirt, hair, etc., may become quite concentrated. For this reason, the water should be drained and replaced every three months depending on use.

- Turn off power at the breaker.
- When water begins to drain out of the hose, be sure to drain the water to a convenient place.



1. Go to the front of your spa and locate the four user friendly fastening system latches



2. Rotate the latches until the cabinet opens up



3. Once inside the cabinet, locate the hose with connector



4. Unscrew the cap off of the connector, then screw your garden hose to the threads of the connector



5. Turn the tab to the open position by aligning it with the tube and connector. This will allow you spa water to flow out.



6. Once your spa has been drained, twist the tab to the closed position. Remove your garden hose, then replace the cap on the connector and simply close up the cabinet door

After draining is completed, Wipe down the inside of your spa making sure your surface is dry and free from standing water. We recommend that after draining or cleaning your spa that you put the cover back on. Avoid exposing the acrylic surface to direct sunlight for an extended period of time. Extended exposure can cause surface fading or cracking, which could void the acrylic warranty.

NOTE!

Note: Be sure that hose is on a downward grade to properly drain swim spa.

WINTERIZING YOUR SWIM SPA

⚠ WARNING!

In areas of the country where the temperatures drop below 32° F, it is important to follow these directions:

When winterizing the swim spa, we recommend putting RV antifreeze in the swim spa and running it before draining the swim spa.

- 1) If the swim spa is not going to be used, drain completely. Be sure all water is removed. Break or loosen unions at each end of pump to ensure water from pump area is removed. Remove pump freeze plugs if so equipped. Using a shop vacuum, vacuum all jets thoroughly to remove any water left over in the plumbing lines.
- 2) Do not turn unit off with water in the swim spa. Frozen water may rupture plumbing. Freeze damage repairs are not covered under warranty.
- 3) Remove and clean filter cartridge. Store cartridge in a secure place to prevent freezing. If the swim spa is going to be used, maintain normal operating procedures and ensure cover is in place when possible.

⚠ NOTE!

Note: Freeze ups or damage caused by freezing are not covered under warranty!

SPRINGTIME START-UP

If your swim spa has been winterized, the Manufacturer highly recommends that you contact an authorized dealer to restart your swim spa. The following is an outline of the procedures involved.

- Make sure all o-rings for pumps are in place and undamaged.
- Make sure all the fittings are tight
- Replace all jet fittings, pump drain plugs, hose bib drains, and bleeder valves.
- Fill the swim spa with water in a normal way,
- Run the jets on high for about 15 minutes.
- Drain the water.
- Put the filters back in.
- Refill the system and treat chemically as one would after a normal water change.

For more information about winterizing your system, or restarting a winterized system, please contact your local Authorized dealer.

TROUBLE SHOOTING GUIDE

No heat or heat too low

- Probable Cause #1 Dirty Filter.
Action Remove filter cartridge and clean.
- Probable Cause #2 Breaker at house off.
Action Reset breaker at house. Breaker can appear to be on and one pole can be off. Turn breaker OFF then ON twice.
- Probable Cause #3 Pump not primed.
Action Refer to the section of this manual on pump priming.
- Probable Cause #4 Improper line voltage.
Action Have a Licensed Electrician check the line voltage.

Pump will not prime

- Probable Cause #1 No water in pump.
Action Make sure water level in swim spa is correct.
- Probable Cause #2 Closed gate valves or blocked lines.
Action Open all gate valves. Check suction for blockage.
- Probable Cause #3 Pump surges, jets lose and gain power, loose union or drain plug.
Action Check union on front or nose of pump to ensure tightness. Check drain plugs to ensure tightness.

Jet(s) won't come on

- Probable Cause #1 Pump not primed.
Action Refer to the section of this manual on pump priming.
- Probable Cause #2 Gates valves closed.
Action Check to see if gate valves are in the correct position. Check to see that pump is plugged in.
- Probable Cause #3 Water Diverter Valve not adjusted correctly.
Action Turn Water Diverter Valve until desired water flow is obtained.
- Probably Cause #4 Individual jet is closed.
Action Turn the outer jet housing clockwise to turn jet on.

Low water flow

- Probable Cause #1 Dirty Filter.
Action Remove filter cartridge and clean.
- Probable Cause #2 Closed gate valves or blocked lines.
Action Open all gate valves.
- Probable Cause #3 Low voltage or incorrect voltage.
Action Have a Licensed Electrician check the line voltage.

TROUBLE SHOOTING GUIDE (CONT.)

Swim spa is leaking

Probable Cause #1..... Loose connection.

Action..... Hand tighten all disconnects and fittings. Check joints and unions.

Motor does not run

Probable Cause #1..... No power to motor.

Action..... Check power switches and circuit breakers. Check motor plug where plugged into control box.

Probable Cause #2..... Pump jammed from foreign matter in impeller.

Action..... Call dealer for recommended action.

Probable Cause #3..... Motor overheats on hot days while filtering.

Action..... Reprogram your controls to cycle during the coolest parts of the day and on shorter cycles. (see programming instructions).

Motor runs hot

Probable Cause #1..... Pump ran dry.

Action..... Call dealer for recommended action.

Probable Cause #2..... Restricted suction lines.

Action..... Make sure all valves are open/clear suction of debris.

Probable Cause #3..... Improper ventilation

Action..... Insure that vents on side of swim spa are free and clear of any debris or landscaping. Swim spa should also be located an adequate distance from any walls or fencing for good ventilation.

NOTE!

Note: These motors will feel hot to the touch. This is normal. The Overheat Sensor will turn the motor off if there is an overload or high temperature problem.

NOTES

NOTES

Limited Warranty Summary

Please refer to the Warranty Card included with your product for complete warranty information. In order to receive prompt warranty service, you must register your swim spa - ask your dealer about registering. The manufacturer provides a limited warranty to our customers. It applies to the swim spa structure, surface, plumbing, pumps, heater, blower, and controls. The limited warranty does not cover damage resulting from improper maintenance, improper installation, misuse, abuse, accident, fire, normal wear and tear, or improper water maintenance. Unauthorized modifications of the swim spa may void the warranty. Replacement costs associated with transportation, removal, and reinstallation are the sole responsibility of the swim spa owner. This manual refers to the swim spa. The manufacturer reserves the right to make changes in design or material of its products at any time without incurring liability. This limited warranty applies to the first retail purchaser and terminates upon any transfer of ownership.

Disclaimer:

The information in this manual is accurate to the best of the manufacturer's knowledge. However, the manufacturer assumes no responsibility for errors or omissions. Nor is any liability assumed for damages resulting from use of the information contained herein.

Safety Sign

The safety sign enclosed with your Owner's Manual packet should be permanently installed where visible to all users of the swim spa. It is very important that you, as a swim spa owner, review the important safety instructions and warnings before you operate your swim spa. It is equally important that you instruct all users, even occasional ones, as to the warnings associated with swim spa use. You may obtain additional signs by contacting:

Dynasty Swim Spas
101 Dynasty Way
Athens, TN 37303
866-396-7727

©2021 Dynasty Spas, Inc. Dynasty Swim spas reserves the right to change product selections and/or make product modifications without notice. Your Dynasty Swim spas Dealer/Contractor is an independent business person and not an agent or employee of Dynasty Swim spas or any of its subsidiaries. Neither Dynasty Swim spas nor its subsidiaries accept any responsibility for any representations, statements or contracts made by any Swim spa Dealer/Contractor.

Swim Spa Manufacturer
1815 Milton St.
Athens, TN 37303
800-951-6224



001237.071221